

Low I_Q , Low Dropout, 800mA, Source and Sink Regulators Adjustable and Fixed 2.5V, 2.85V, 5V Output

FEATURES

- Regulates While Sourcing or Sinking Current
- Provides Termination for up to 27 SCSI Lines
- 600 μ A Quiescent Current
- Ultralow Power Shutdown Mode
- Current Limit and Thermal Shutdown Protection
- Stable for Any $C_{LOAD} \geq 0.22\mu$ F
- Fast Settling Time
- 1V Dropout Voltage

APPLICATIONS

- Active Negation SCSI Terminations
- Computers
- Disk Drives
- CD-ROM
- Supply Splitter

DESCRIPTION

The LT[®]1118 family of low dropout regulators has the unique capability of maintaining output regulation while sourcing or sinking load current. The 2.85V output voltage regulator is ideal for use as a Boulay termination of up to 27 SCSI data lines. The regulator maintains regulation while both sourcing and sinking current, enabling the use of active negation drivers for improved noise immunity on the data lines. Regulation of output voltage is maintained for TERMPWR voltages as low as 4.0V. When unloaded, quiescent supply current is a low 600 μ A, allowing continuous connection to the TERMPWR lines. An ultralow power shutdown mode is also available on the SO-8 version. In Shutdown the output is high impedance and supply current drops to less than 10 μ A.

Current limits in both sourcing and sinking modes, plus on-chip thermal shutdown make the circuit tolerant of output fault conditions.

The LT1118 is available in 3-lead SOT-223 and 8-lead SO packages.

LT, LT, LTC and LTM are registered trademarks of Linear Technology Corporation. All other trademarks are the property of their respective owners.

TYPICAL APPLICATION

Load Transient Response

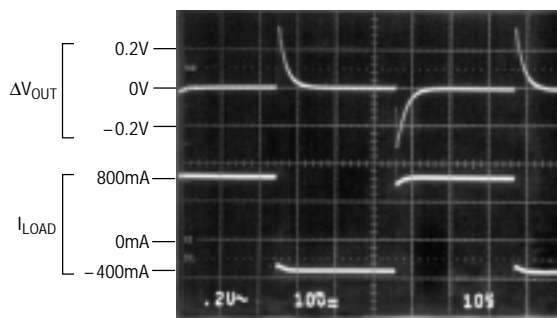
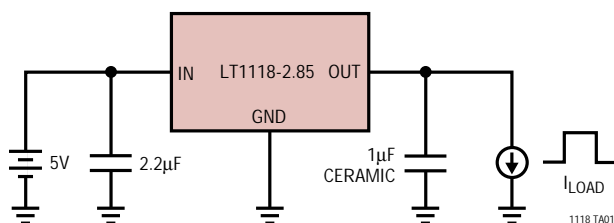

1118 TA02.tif

LT1118/LT1118-2.5 LT1118-2.85/LT1118-5

ABSOLUTE MAXIMUM RATINGS (Note 1)

Supply Voltage (V_{CC})	15V	Operating Temperature Range	0°C to 70°C
Input Voltage (Enable)	-0.2V to 7V	Storage Temperature Range	-65°C to 150°C
Output Voltage	-0.2V to $V_{CC} + 0.5V$	Lead Temperature (Soldering, 10 sec)	300°C
Short-Circuit Duration	Indefinite		

PACKAGE DESCRIPTION

<p>S8 PACKAGE 8-LEAD PLASTIC SO $T_{JMAX} = 125^{\circ}C, \theta_{JC} = 15^{\circ}C/W$</p>		<p>S8 PACKAGE 8-LEAD PLASTIC SO $T_{JMAX} = 125^{\circ}C, \theta_{JC} = 15^{\circ}C/W$</p>		<p>ST PACKAGE 3-LEAD PLASTIC SOT-223 $T_{JMAX} = 125^{\circ}C, \theta_{JC} = 15^{\circ}C/W$</p>	
ORDER PART NUMBER	S8 PART MARKING	ORDER PART NUMBER	S8 PART MARKING	ORDER PART NUMBER	ST PART MARKING
LT1118CS8	1118	LT1118CS8-2.5	111825	LT1118CST-2.5	111825
		LT1118CS8-2.85	111828	LT1118CST-2.85	111828
		LT1118CS8-5	11185	LT1118CST-5	11185
Order Options Tape and Reel: Add #TR Lead Free: Add #PBF Lead Free Tape and Reel: Add #TRPBF Lead Free Part Marking: http://www.linear.com/leadfree/					

Consult LTC Marketing for parts specified with wider operating temperature ranges.

ELECTRICAL CHARACTERISTICS

The ● denotes specifications which apply over the full operating temperature range, otherwise specifications are at $T_A = 25^{\circ}C$. (Note 2)

PARAMETER	CONDITIONS	MIN	TYP	MAX	UNITS
Quiescent Current (V_{IN})	$V_{EN} = 5V$ ●		0.6	1	mA
Quiescent Current in Shutdown (V_{IN})	$V_{EN} = 0V$ ●		1	10	μA
Enable Input Thresholds	Input Low Level ●	0.4	1.4		V
	Input High Level ●		1.4	2	V
Enable Input Current	$0V \leq V_{EN} \leq 5V$ ●	-1		25	μA
Feedback Voltage	LT1118 No Load (25°C)	1.213	1.225	1.237	V
	All Operating Conditions (Note 3) ●	1.200	1.225	1.250	V
Output Voltage	LT1118-2.5 No Load (25°C)	2.47	2.5	2.53	V
	All Operating Conditions (Note 3) ●	2.45	2.5	2.55	V
	LT1118-2.85 No Load (25°C)	2.82	2.85	2.88	V
	All Operating Conditions (Note 3) ●	2.79	2.85	2.91	V
LT1118-5	No Load (25°C)	4.95	5	5.05	V
	All Operating Conditions (Note 3) ●	4.90	5	5.1	V

ELECTRICAL CHARACTERISTICS

The ● denotes specifications which apply over the full operating temperature range, otherwise specifications are at $T_A = 25^\circ\text{C}$. (Note 2)

PARAMETER		CONDITIONS	MIN	TYP	MAX	UNITS
Line Regulation (Note 4)	LT1118	$I_L = 0\text{mA}$, $4.2\text{V} \leq V_{IN} \leq 15\text{V}$	●		6	mV
	LT1118-2.5	$I_L = 0\text{mA}$, $4.2\text{V} \leq V_{IN} \leq 15\text{V}$	●		6	mV
	LT1118-2.85	$I_L = 0\text{mA}$, $4.75\text{V} \leq V_{IN} \leq 15\text{V}$	●		6	mV
	LT1118-5	$I_L = 0\text{mA}$, $6.5\text{V} \leq V_{IN} \leq 15\text{V}$	●		10	mV
Load Regulation (Note 4)	LT1118	$0\text{mA} \leq I_L \leq 800\text{mA}$	●		6	mV
		$-400\text{mA} \leq I_L \leq 0\text{mA}$	●		6	mV
	LT1118-2.5	$0\text{mA} \leq I_L \leq 800\text{mA}$	●		12	mV
		$-400\text{mA} \leq I_L \leq 0\text{mA}$	●		12	mV
LT1118-2.85	$0\text{mA} \leq I_L \leq 800\text{mA}$	●		12	mV	
	$-400\text{mA} \leq I_L \leq 0\text{mA}$	●		12	mV	
Dropout Voltage (Note 5)		$I_L = 100\text{mA}$		0.85	1.1	V
		$I_L = 800\text{mA}$		1	1.3	V
FB Pin Bias Current	LT1118			0.35	1	μA
Minimum Output Voltage	LT1118		●		2.1	V
Ripple Rejection		$f_{\text{RIPPLE}} = 120\text{Hz}$, $V_{IN} - V_{OUT} = 2\text{V}$ $V_{\text{RIPPLE}} = 0.5\text{V}_{\text{P-P}}$		60	80	dB
Load Transient Settling Time, $\Delta V = 1\%$		$0\text{mA} \leq I_L \leq 800\text{mA}$, $C_{\text{LOAD}} = 1\mu\text{F}$		5		μs
		$-400\text{mA} \leq I_L \leq 0\text{mA}$, $C_{\text{LOAD}} = 1\mu\text{F}$		5		μs
Output Short-Circuit Current	I_{SC}^+	$V_{\text{OUT}} = 0\text{V}$		800	1200	mA
	I_{SC}^-	$V_{\text{OUT}} = V_{IN}$			-700 -400	mA
Thermal Shutdown Junction Temperature		No Load		170		$^\circ\text{C}$
Enable Turn-On Delay		No Load		50		μs

Note 1: Stresses beyond those listed under Absolute Maximum Ratings may cause permanent damage to the device. Exposure to any Absolute Maximum Rating condition for extended periods may affect device reliability and lifetime.

Note 2: Unless otherwise specified, testing done at $V_{\text{CC}} = 5\text{V}$ (LT1118-2.5, LT1118-2.85) or $V_{\text{CC}} = 7\text{V}$ (LT1118-5). $V_{\text{EN}} = V_{\text{CC}}$. Output $C_{\text{LOAD}} = 1\mu\text{F}$, $I_{\text{LOAD}} = 0$.

Note 3: All operating conditions include the combined effects of load current, input voltage and temperature over each parameter's full range.

Note 4: Load and line regulation are tested at a constant junction temperature by low duty cycle pulse testing.

Note 5: Dropout voltage is defined as the minimum input to output voltage measured while sourcing the specified current.

TYPICAL PERFORMANCE CHARACTERISTICS

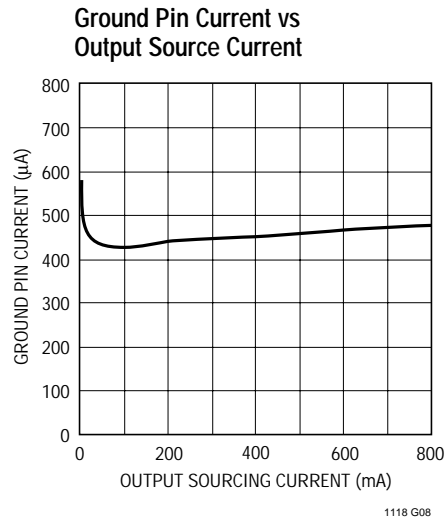
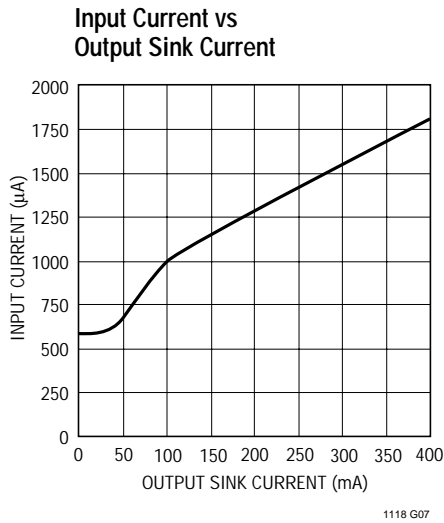
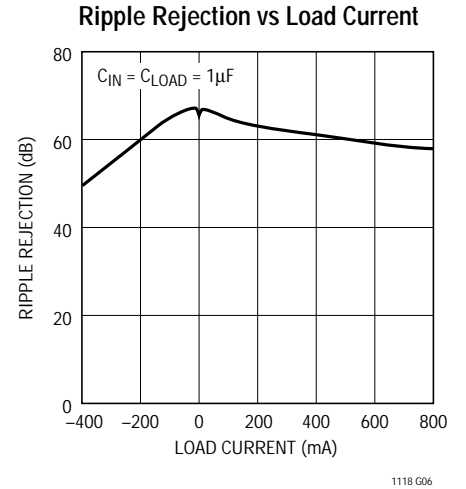
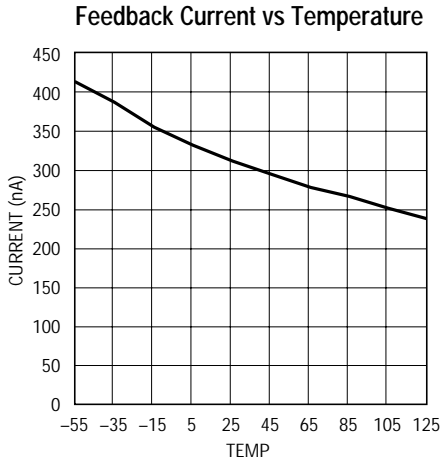
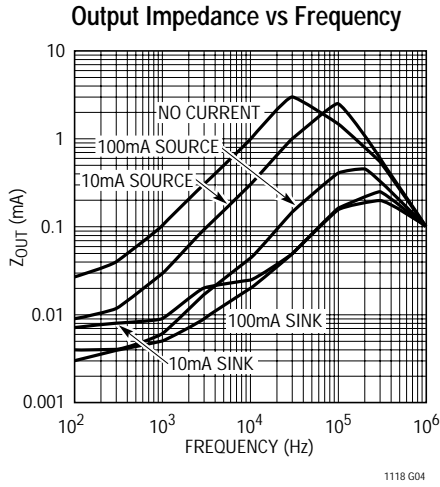
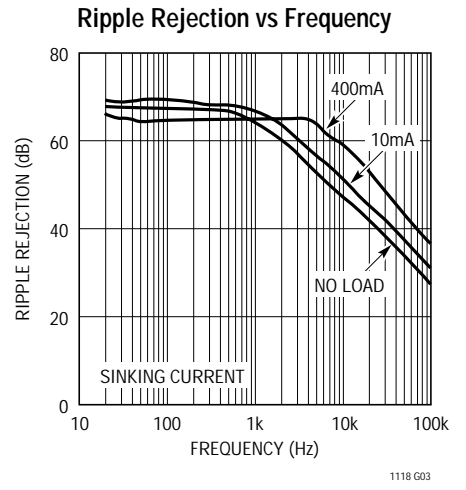
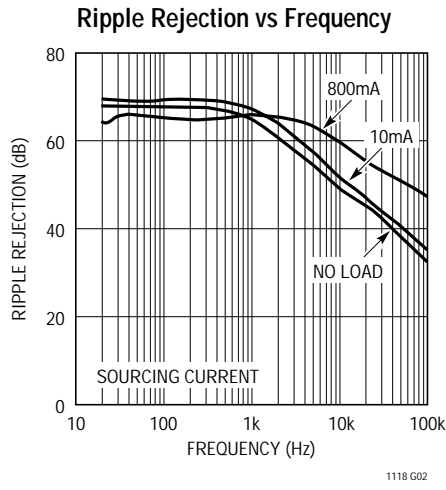
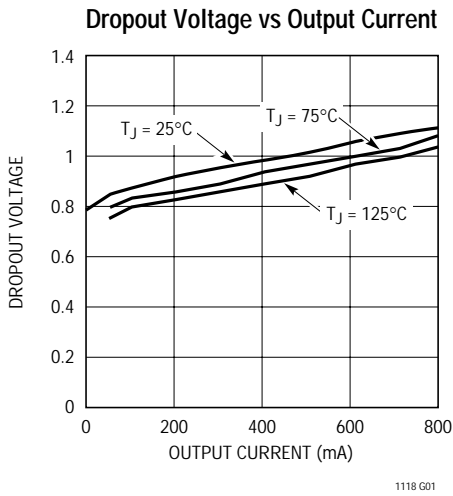

PIN FUNCTIONS

IN: Input Supply Pin. This pin should be decoupled with a 1 μ F or larger low ESR capacitor. The two IN pins on the SO-8 package must be directly connected on the printed circuit board to prevent voltage drops between the two inputs. When used as a SCSI active termination, IN connects to term power. When used as a supply splitter, IN is also the positive supply output.

GND: Ground Pin. The multiple GND pins on the SO-8 package are internally connected, but lowest load regulation errors will result if these pins are tightly connected on the printed circuit board. This will also aid heat dissipation at high power levels.

EN: TTL/CMOS Logic Input. A high level allows normal operation. A low level reduces supply current to zero. This pin is internally connected to V_{IN} on 3-lead ST packaged devices.

OUT: Regulated Output Voltage. Output can source or sink current. Current limit for sourcing and sinking current is provided to protect the device from fault conditions. The output must have a low ESR output filter capacitor. C_{OUT} \geq 0.22 μ F to guarantee stability. A 0.1 μ F ceramic capacitor may be needed in parallel with C_{OUT} if the ESR of the main C_{OUT} is too high.

FB: Feedback Pin. The feedback pin is used to program the output voltage of the adjustable S8 part. The output voltage range that can be achieved is 2.1V to 6.5V. The output voltage is determined by the selection of feedback resistors defined by the following formula:

$$V_{OUT} = V_{FB} \left(1 + \frac{R_1}{R_2} \right) + I_{FB} R_1$$

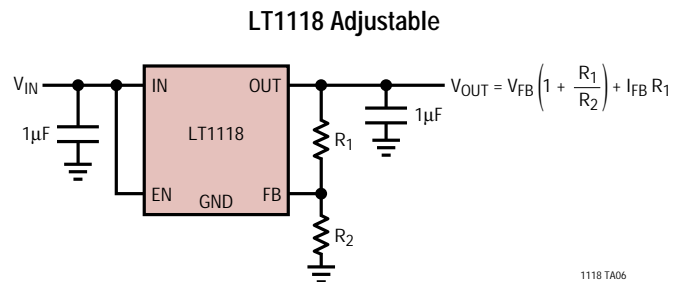

OPERATION

Output Capacitor

The LT1118 family of voltage regulators require an output capacitor for stability. The regulators are stable with output capacitors larger than 0.2 μ F. Load transient response is very sensitive to output capacitor value and dielectric choice. Low ESR ceramic capacitors are the best choice for fast settling to load transients. Output capacitors between 0.2 μ F and 1 μ F give good performance in most applications. Larger tantalum output capacitors may be used to reduce load transient amplitudes. Larger capacitors should be paralleled with a 0.1 μ F ceramic capacitor to maintain quick settling time performance and to insure stability of the regulator control loop. Capacitors larger than 10 μ F may be safely used with the regulators, but little transient settling performance improvement results from their use.

Worst case transient response of the LT1118 regulators occurs at zero output current. In order to obtain the fastest transient settling performance, the regulator output may be preloaded with a small current. The preload current reduces the regulator output impedance, reducing output voltage settling time.

Thermal Considerations

The LT1118 regulators are packaged in plastic SOT-223 and fused lead S8 packages. These small footprint packages are unable to convectively dissipate the heat generated when the regulator is operating at high current levels. In order to control die operating temperatures, the PC board layout should allow for maximum possible copper area at the ground pins of the LT1118. The ground pins and the tab on the SOT-223 package are electrically and

LT1118/LT1118-2.5 LT1118-2.85/LT1118-5

OPERATION

thermally connected to the die substrate. Table 1 shows measured thermal resistance from junction to ambient for the LT1118 connected to various sized PC board ground planes. The power dissipated in the LT1118 varies with input voltage and loading. When the regulator is sourcing current the power which must be dissipated by the package is:

$$P_D = (V_{IN} - V_{OUT}) \cdot I_{LOAD}$$

When the regulator is sinking load current, power dissipation is nearly independent of V_{IN} and can be calculated as:

$$P_D = V_{OUT} \cdot I_{LOAD}$$

Heat sinking to the IC package must consider the worst case power dissipation which may occur.

Table 1. Measured Thermal Resistance from Junction to Ambient for the LT1118

	S8 Package	SOT-223
Free Air	120°C/W	95°C/W
1 Sq Inch Copper	55°C/W	53°C/W
4 Sq Inch Copper	35°C/W	38°C/W

TYPICAL APPLICATIONS

SCSI Active Terminator

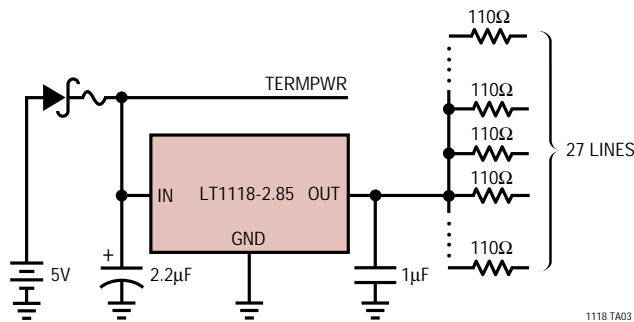

Power Supply Splitter

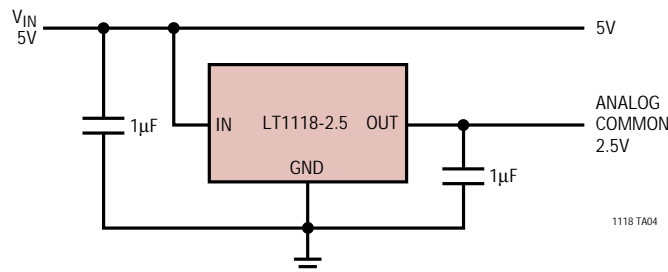

PACKAGE DESCRIPTION

ST Package
3-Lead Plastic SOT-223
 (LTC DWG # 05-08-1630)

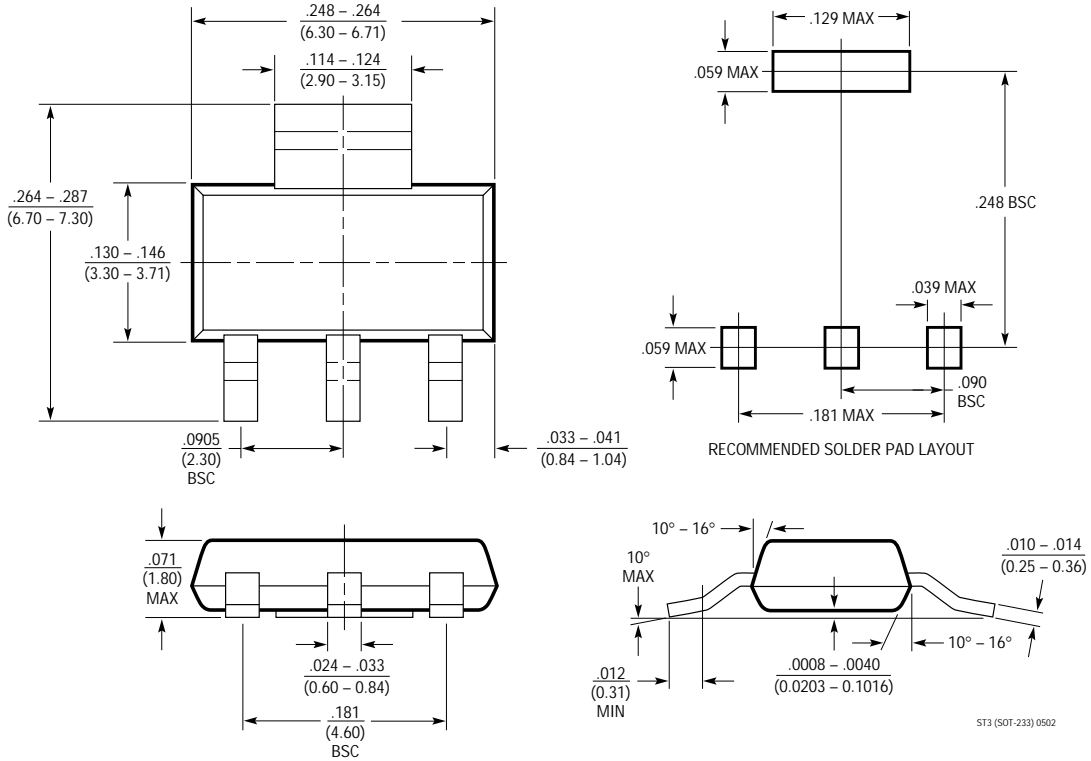

S8 Package
8-Lead Plastic Small Outline (Narrow 0.150)
 (LTC DWG # 05-08-1610)

